

S-BOX-USB SteppIR with Tuning Relay Interrupt, KPA1500 via RXD

KPA1500: 5 GND, 10 KEY IN

PC USB: CAT

To PC Serial Port

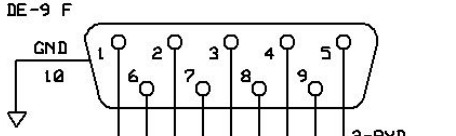

SteppIR DATA IN

To SteppIR or 2nd Serial

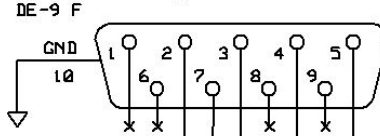

To SteppIR or 3rd Serial

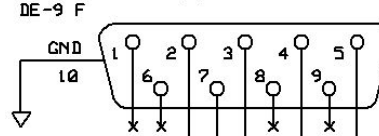

KPA1500 AUX

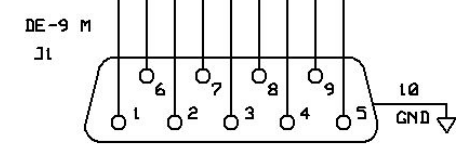
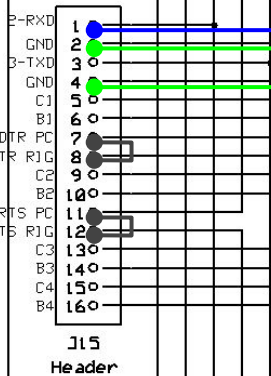
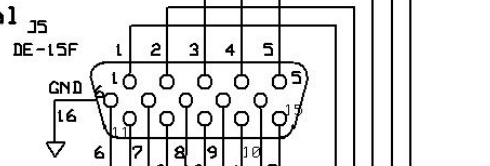

To Radio RS-232 or P3 "PC" Conn.

Yaesu CAT or Kenwood COM

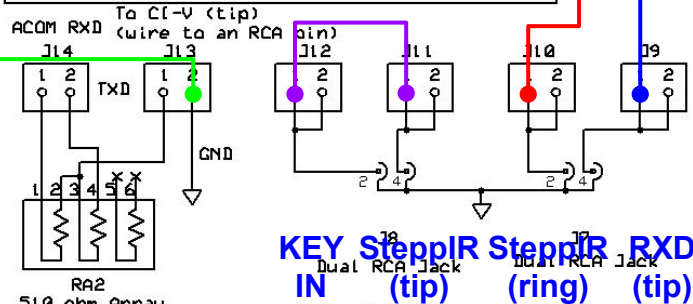

To ACOM Only (from ICOM)

KEY SteppIR SteppIR RXD ← From KPA1500
IN (tip) (ring) (tip) XCVR SERIAL

N6TV		
1x3 DE-9 Splitter with DE-15		
R. A. Wilson	Ver 1.2	Page 1 of 1
	03/05/2018	