

SPE: 1 RXD, 3 TX TTL, 4 GND, 8 RemON, 9 TXD, 10 RXTTL/CI-V, 11 KenTTL GND, 12 RLY

**microKEYER II  
RS-232**

To PC Serial Port

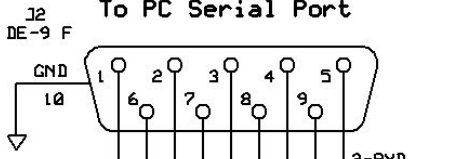

**SteppIR  
DATA IN**

To SteppIR or 2nd Serial

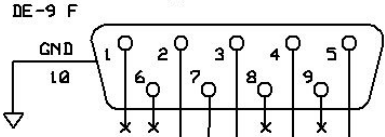

To SteppIR or 3rd Serial

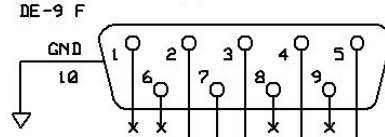

**SPE  
CAT**

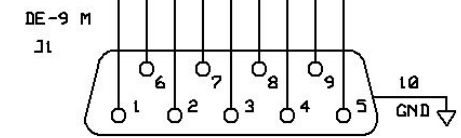
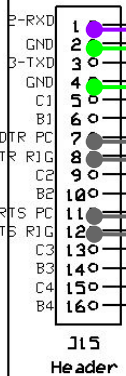
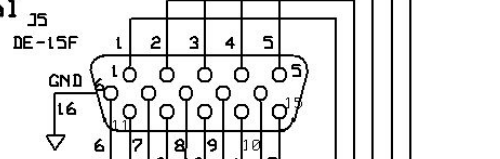

To Radio RS-232 or P3 "PC" Conn.

**Transceiver  
CAT**

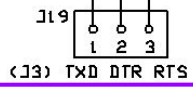

(J3) TXD DTR RTS

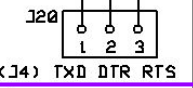

(J4) TXD DTR RTS

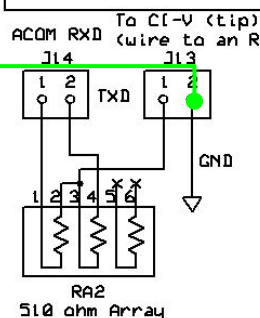
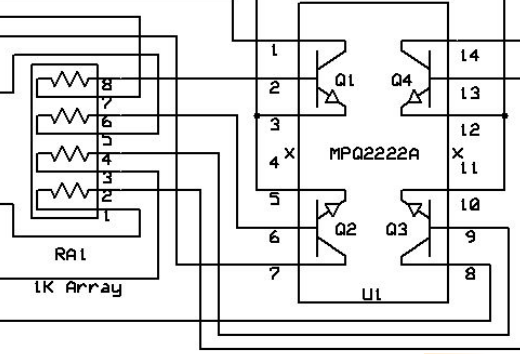

To ACOM Only (from ICOM)

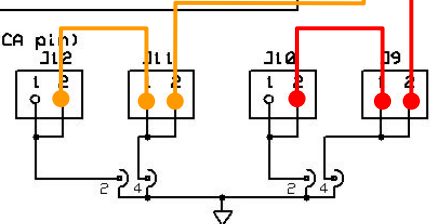

**TX GND**    **PTT**    **REM ON**  
Dual RCA Jack    Dual RCA Jack

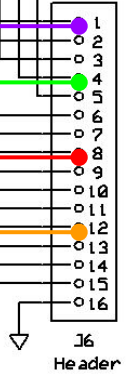

N6TV

**1x3 DE-9 Splitter with DE-15**

R. A. Wilson	Ver 1.2	Page 1 of 1
	03/05/2018	